

modello

COMPACT 8

VERTICALI

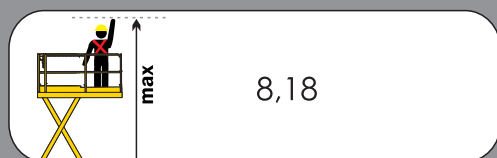
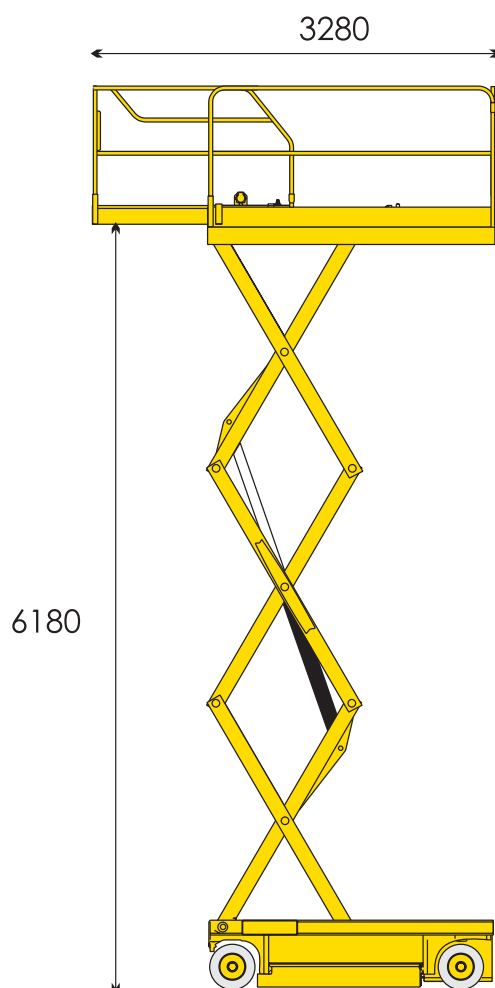
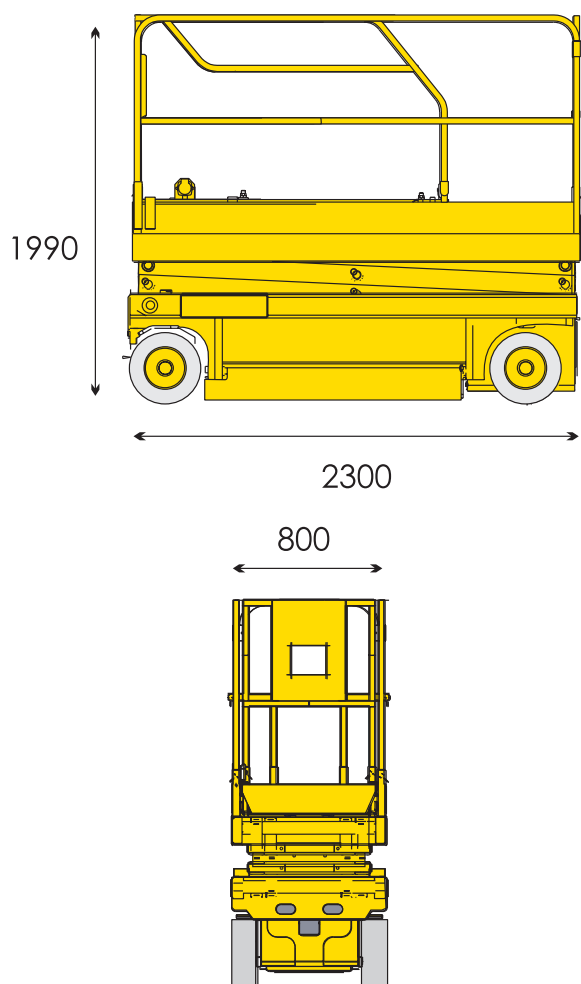

8,18

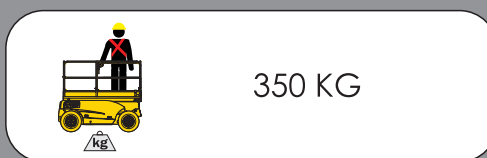

350 KG

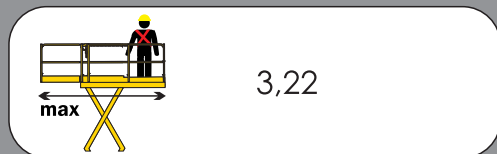
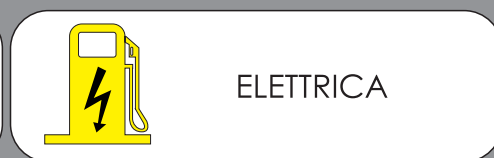

3,22

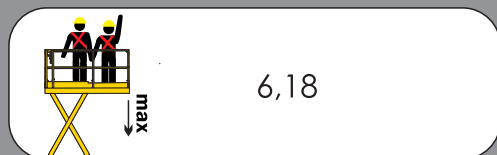
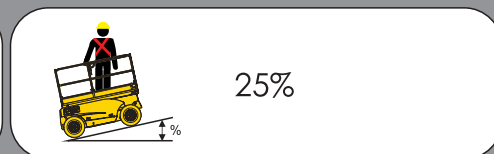
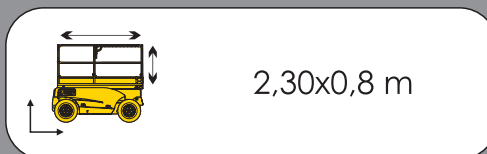

6,18

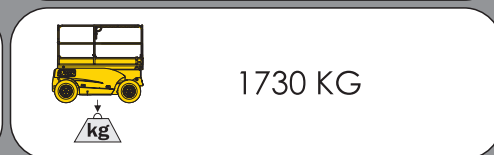
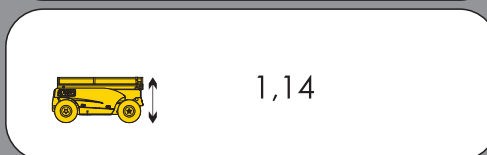

1730 KG